

EPS 1-017
Aufsatzprofil AP 84
Retrofit AP 84

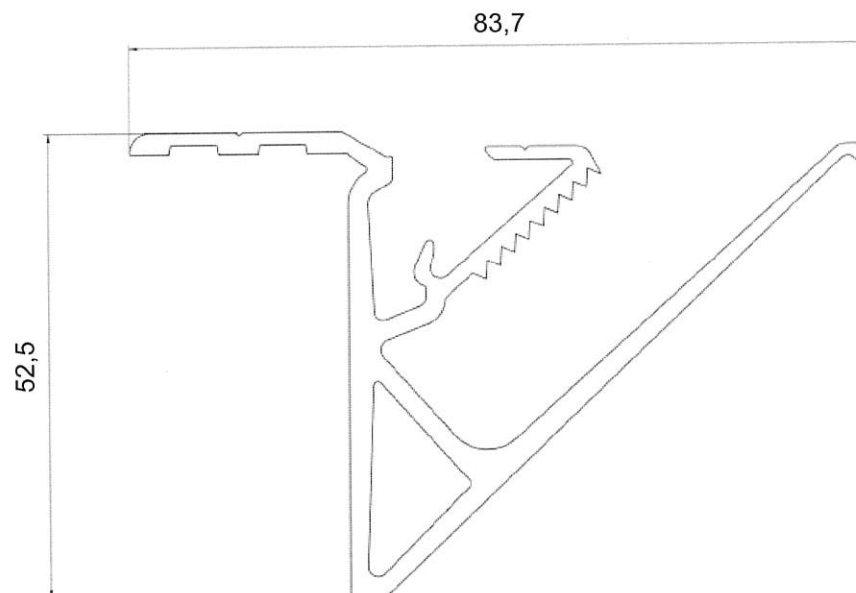

Technische Änderungen vorbehalten.
Technical changes are reserved.