

EPS.LUMI GRIP

Technical Documentation

07.2022

	Page
Basic knowledge	
Fabric allowance LUMI-GRIP	4
Attachement of the flex holder	5
Fabric tensioning	6 - 7
Assembly boxes	
BOX S-150	9
BOX S-67	11
DISPLAY S-50	12
DISPLAY S-67	13
Technical additional information	
Statics and special designs	15
Order information for kits	16
Bending	17

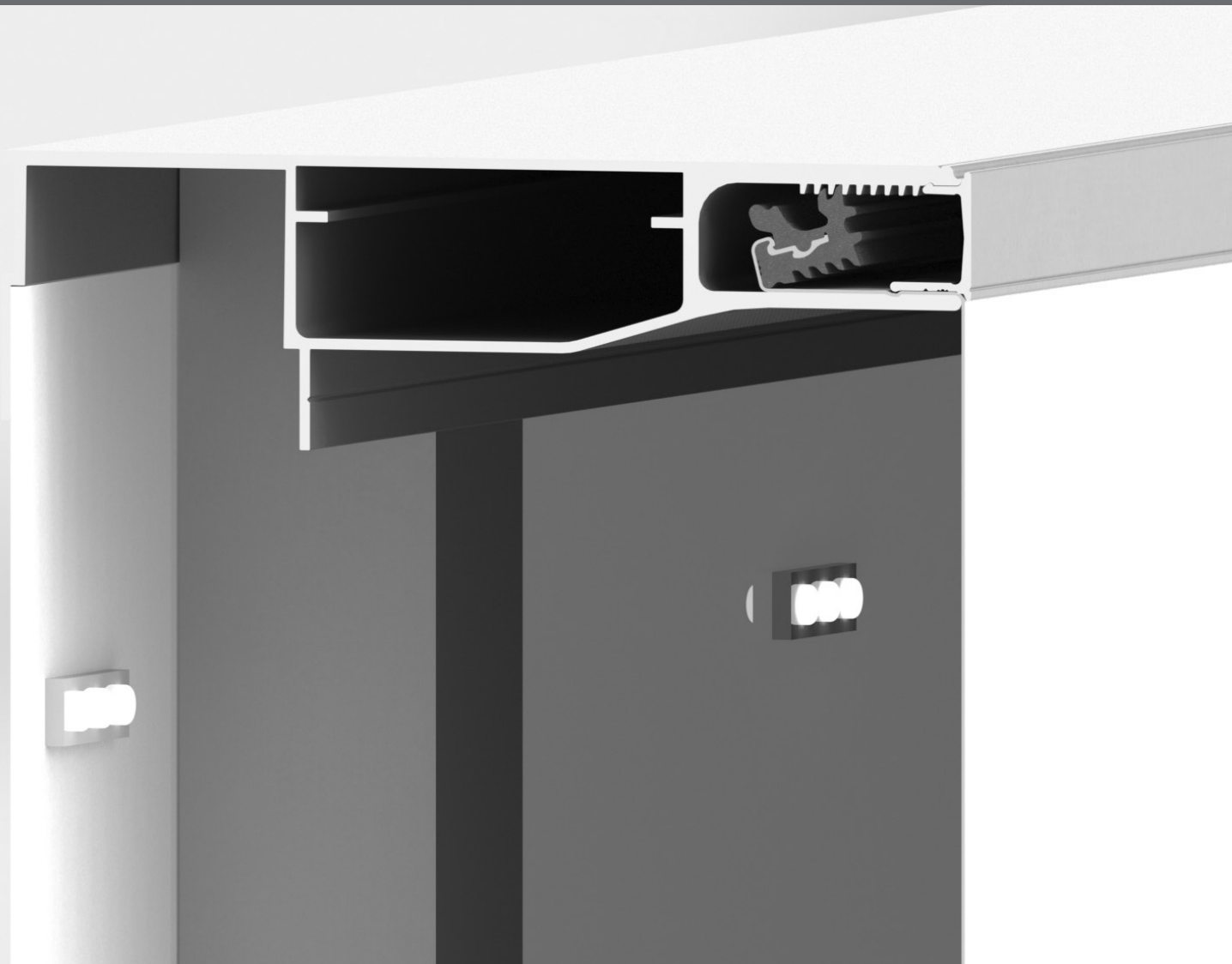

**Basic knowledge
Fabric tensioning**

The profile can be fitted from the front and is particularly suited to installation in recesses.

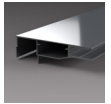

Profiles for non-illuminated wall displays can be fixed directly to the wall without a substructure.

Fabric allowance and fabric cutting LUMI-GRIP

Please note the range of backlit fabrics on offer. We gladly assist you in selecting the fabric for your project.

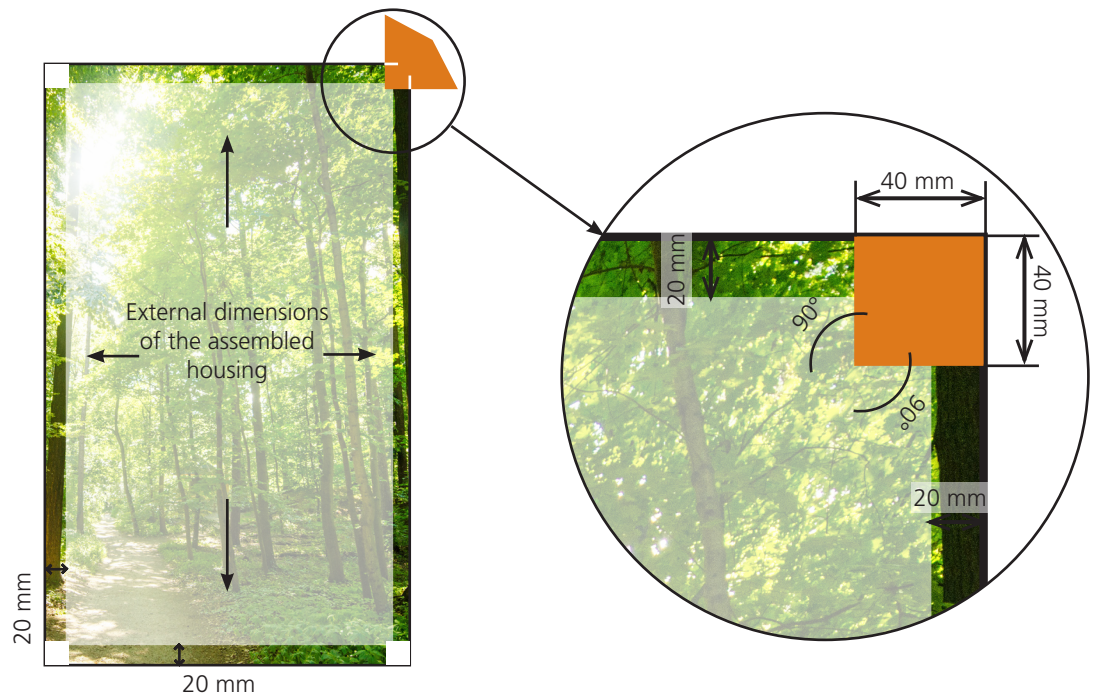

Add 20 mm to the external dimensions of the housing.

Remove the orange area of the fabric.

The mass per unit area of a PVC coated polyester fabric should be at least 550 grams/square metre. In the event of a lower mass per unit area, the edge may need to be reinforced because the flexholder does not grip.

For formats with a length > 4 m, we recommend cutting the precise fabric allowance on site when in a half-tensioned state and then clamping the flex holders into place since temperature differences may influence the size of the fabric. If the fabric is still too long, release the flex holders with the flex holder pliers and cut the fabric down again.

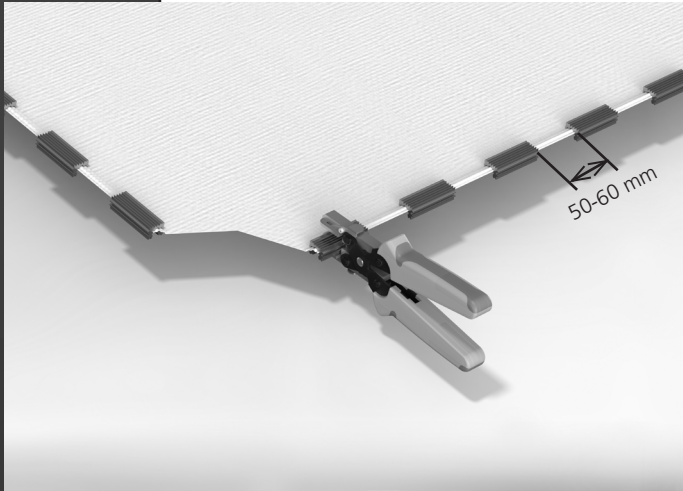

Starting from the corner of the fabric, the flex holders are applied with gaps of 50 - 60 mm between them. In order to achieve optimum tension: the larger the fabric area, the smaller the gaps between the holders.

Using the flex holder pliers, compress the flex holder on the fabric until it engages perceptibly. Important: The flex holder must, as shown, have the finely toothed side facing the visible area of the fabric when clamping.

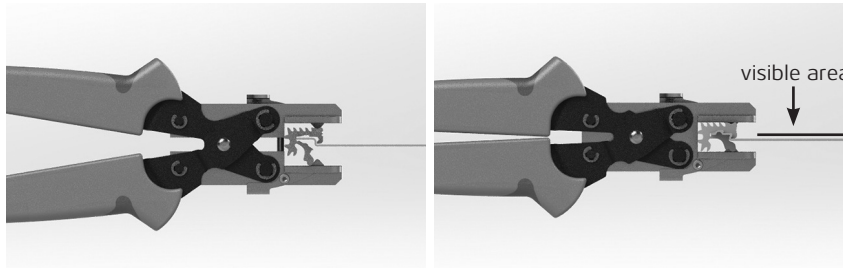

To open the flex holder, the clamping lug of the flex holder must be bent open in the opposite direction.

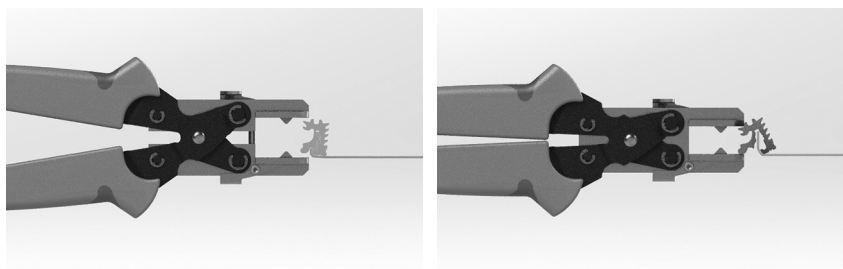

In order to be able to clamp the fabric correctly, the flex holder is folded once in the direction of the visible area and then inserted in the clamping channel of the profile!

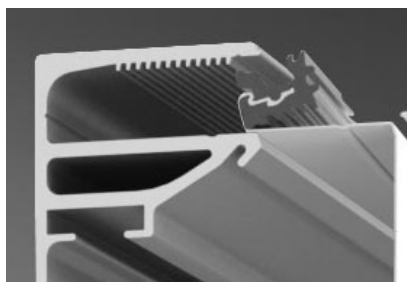

When installing PVC coated fabric a minimum ambient temperature of 8° Celsius should be ensured. In the event of lower temperatures, the fabric may buckle or be damaged in other ways. For small and medium formats, do not tension the fabric too firmly.

For formats with a length > 4 m, we recommend cutting the precise fabric allowance on site when in a half-tensioned state and then clamping the flex holders into place since temperature differences may influence the size of the fabric. If the fabric is still too long, release the flex holders with the flex holder pliers and cut the fabric down again.

Do not equip the frames with fabric when they are lying down since the fabric sags as a result of its own weight and you will thus have difficulties engaging the flex holders in the LUMI profile. In order to ensure optimum tensioning, always ensure the frame is upright.



Insert the first three flex holders on the sides and the top edge and engage into the first or second tooth of the profile. When inserting each flex holder pull the fabric firmly away from the starting point in order to prevent wrinkles.

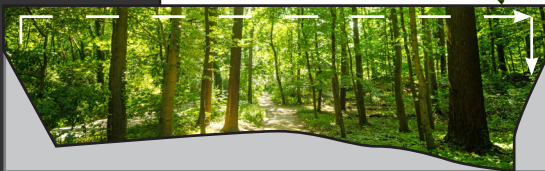

To finish the top row, insert the first flex holder on the opposite side and engage.

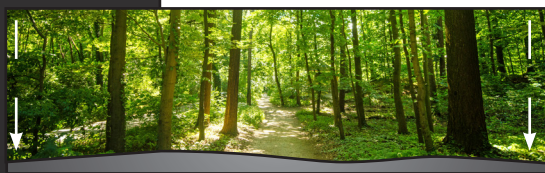

Finish inserting the side flex holders and engage into the first or second tooth.

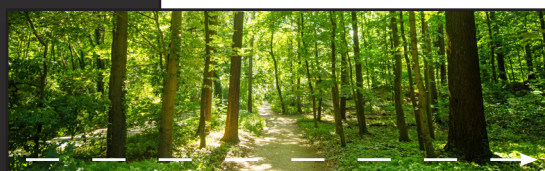

Insert the bottom flex holders and engage into the first or second tooth. Only when this step is completed may you start actually tensioning using tensioning tools.



Use a tensioning fastener to push the flex holders on the left and right deeper into the profile and thus to tension the flex.

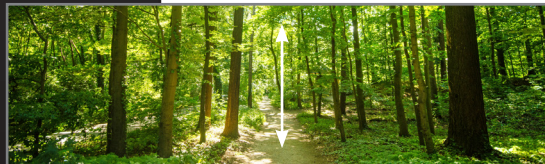

Then push the flex holders along the top and bottom edges deeper into the profile. If necessary, go round all flex holders again and tension further.

Tensioning the fabric

Minimum tensioning depth of the flex holder

In order to ensure that the fabric is provided with optimum and secure tension when you have completed tensioning, the flex holders should be engaged in the middle section of the tooting of the tensioning profile.

Tensioning with flex holder fastener and rubber hammer

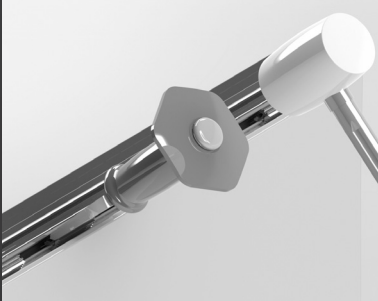

In order to securely tension the fabric, apply the flex holder fastener like a chisel to the flex holder and use the mallet to drive it deeper into the profile. For small and medium formats, do not tension the fabric too firmly.

Then seal the tensioning channel with the cover profile and use screws to prevent it from springing off unintentionally.

IMPORTANT NOTE:

When using black or dark fabrics, as well as those where the entire surface has dark print or lettering, the heat generated as a result of direct sunlight may cause wrinkles to appear.

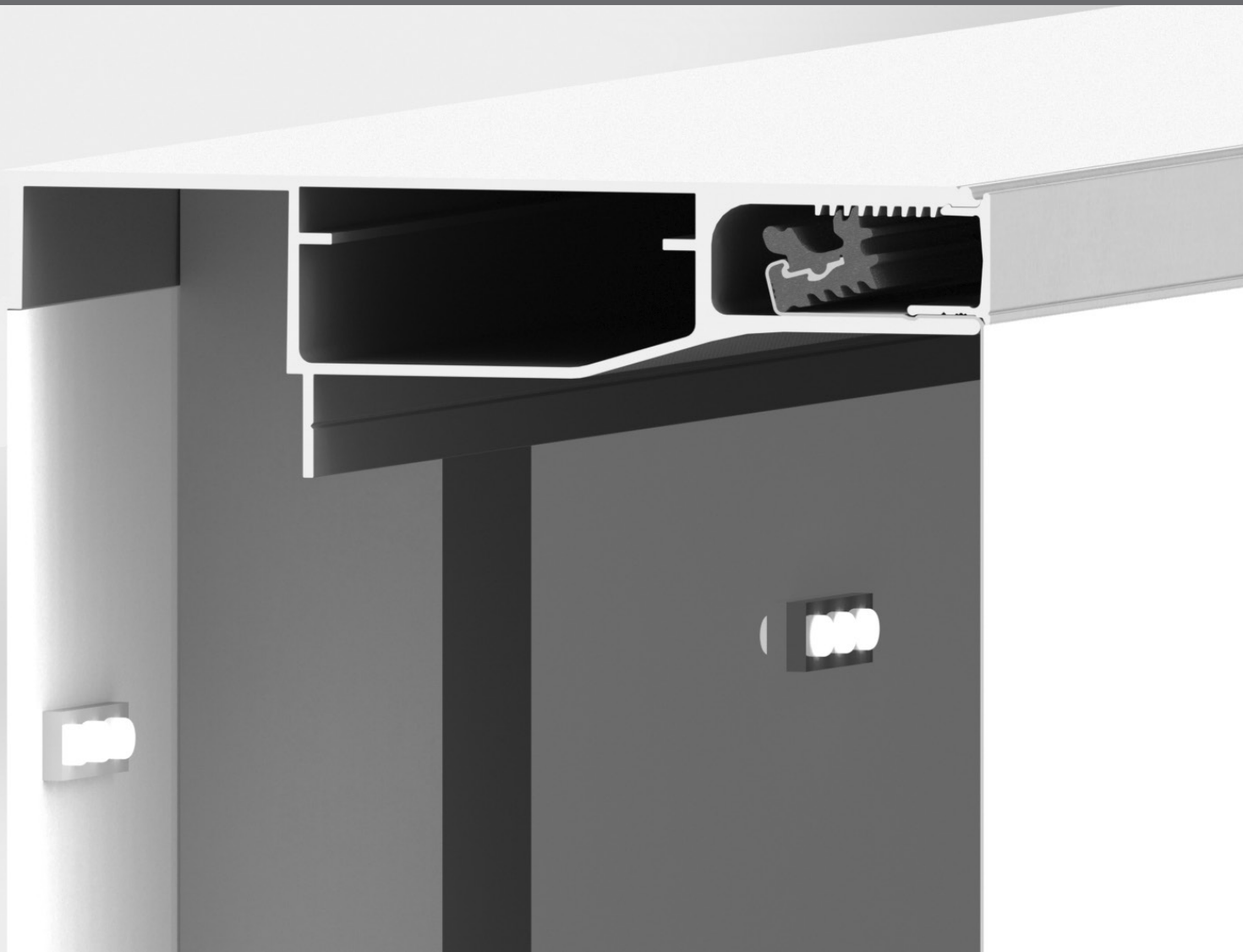

Assembly Boxes

Please note:

- Fabric allowance circumferential 20 mm
- Always secure the cover profile with screws.
- The profile EPS 1-102 cannot be bent.

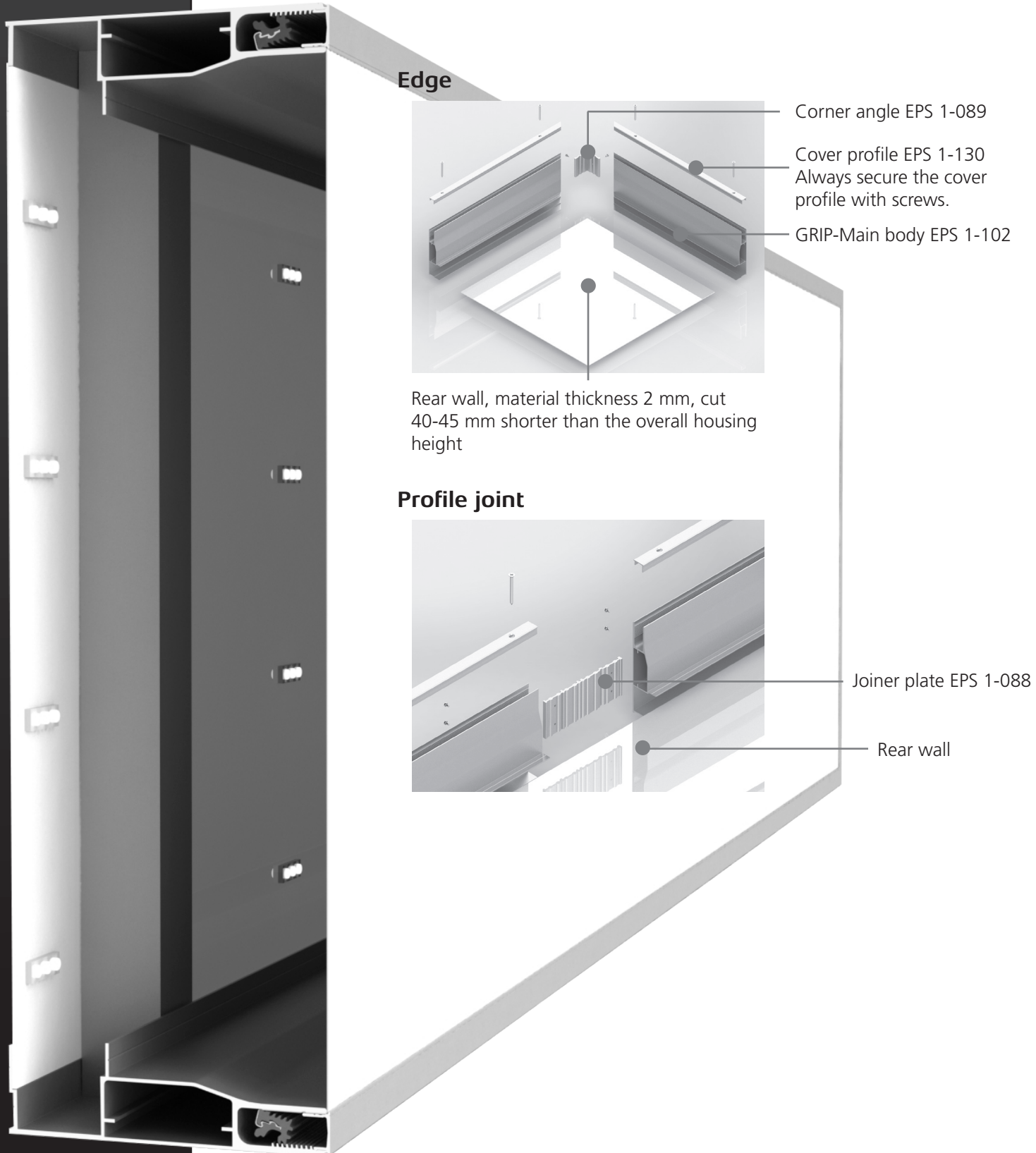

Stiffening version 1: Rear wall behind stiffening

Rear wall: material thickness 2 mm, cut 40-45 mm smaller than the frame format

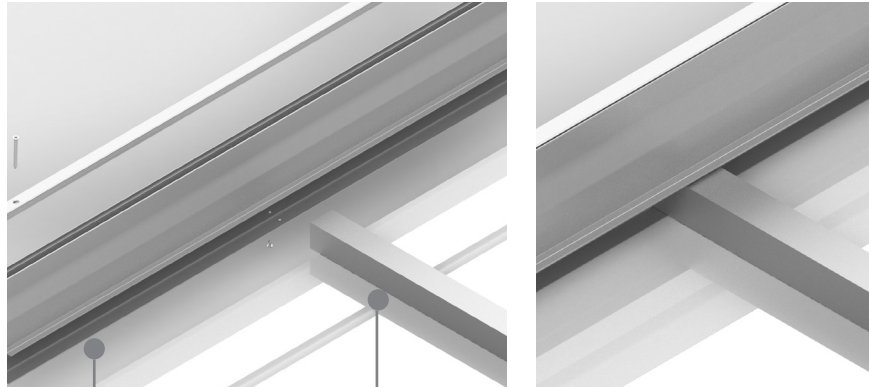

Screwing on profile

Aluminium tube EPS 12-055 approx. 5 mm shorter than the frame format and insert into the corresponding groove.

Stiffening version 2: Rear wall in front of stiffening

Rear wall: material thickness 2 mm, cut 60-65 mm smaller than the frame format

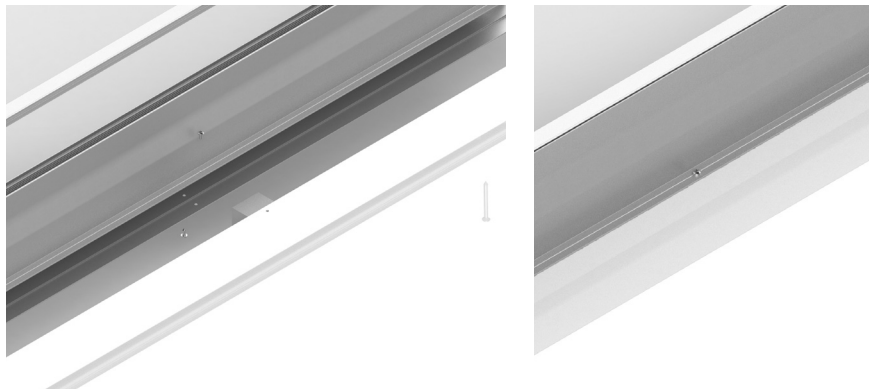

Please note:

- Fabric allowance circumferential 20 mm
- Always secure the cover profile with screws.
- Notes on bending see page 18.



Edge

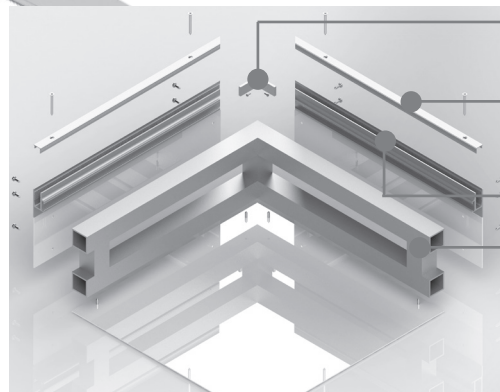

Corner angle EPS 1-050

Cover profile EPS 1-130
Always secure the cover profile with screws

GRIP Retrofit EPS 1-111

Substructure

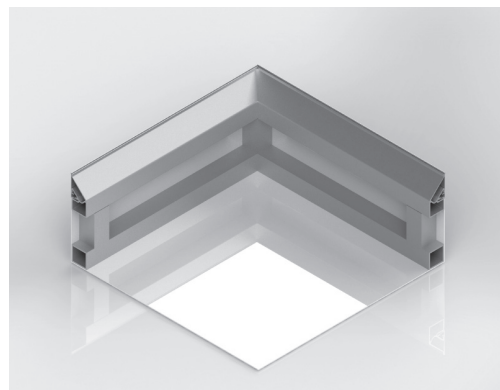

Rear wall and cutting self-made reinforcement of welded square tube is to be selected by the processor himself.

Double-sided frame (BOX D-67)



Please note:

- Fabric allowance circumferential 20 mm
- Always secure the cover profile with screws.
- Assembly instruction display on page 17.
- Notes on bending see page 18.

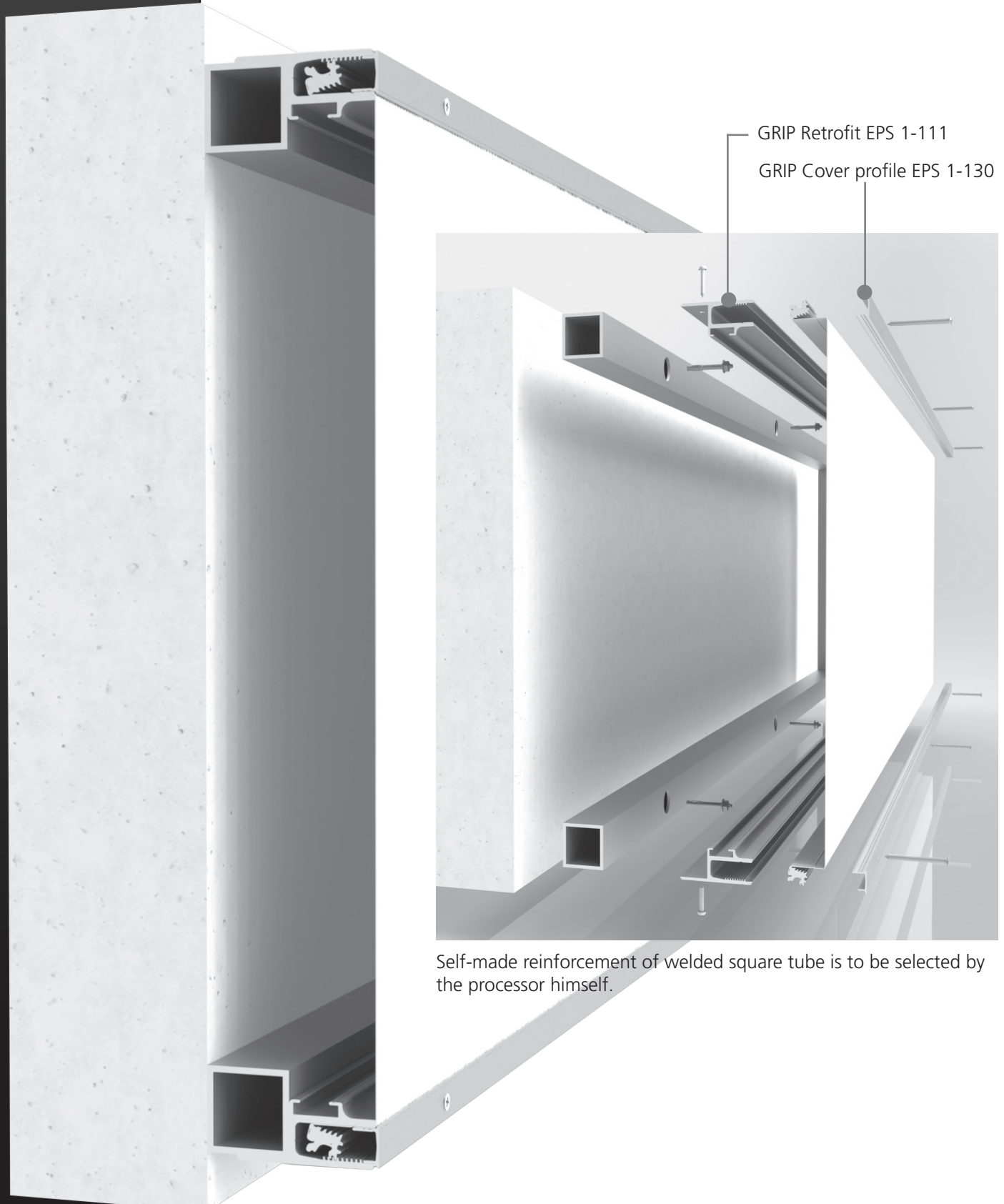

Self-made reinforcement of welded square tube is to be selected by the processor himself.

Please note:

- Fabric allowance circumferential 20 mm
- Always secure the cover profile with screws.
- Assembly instruction display on page 17.
- The profile EPS 1-121 cannot be bent.



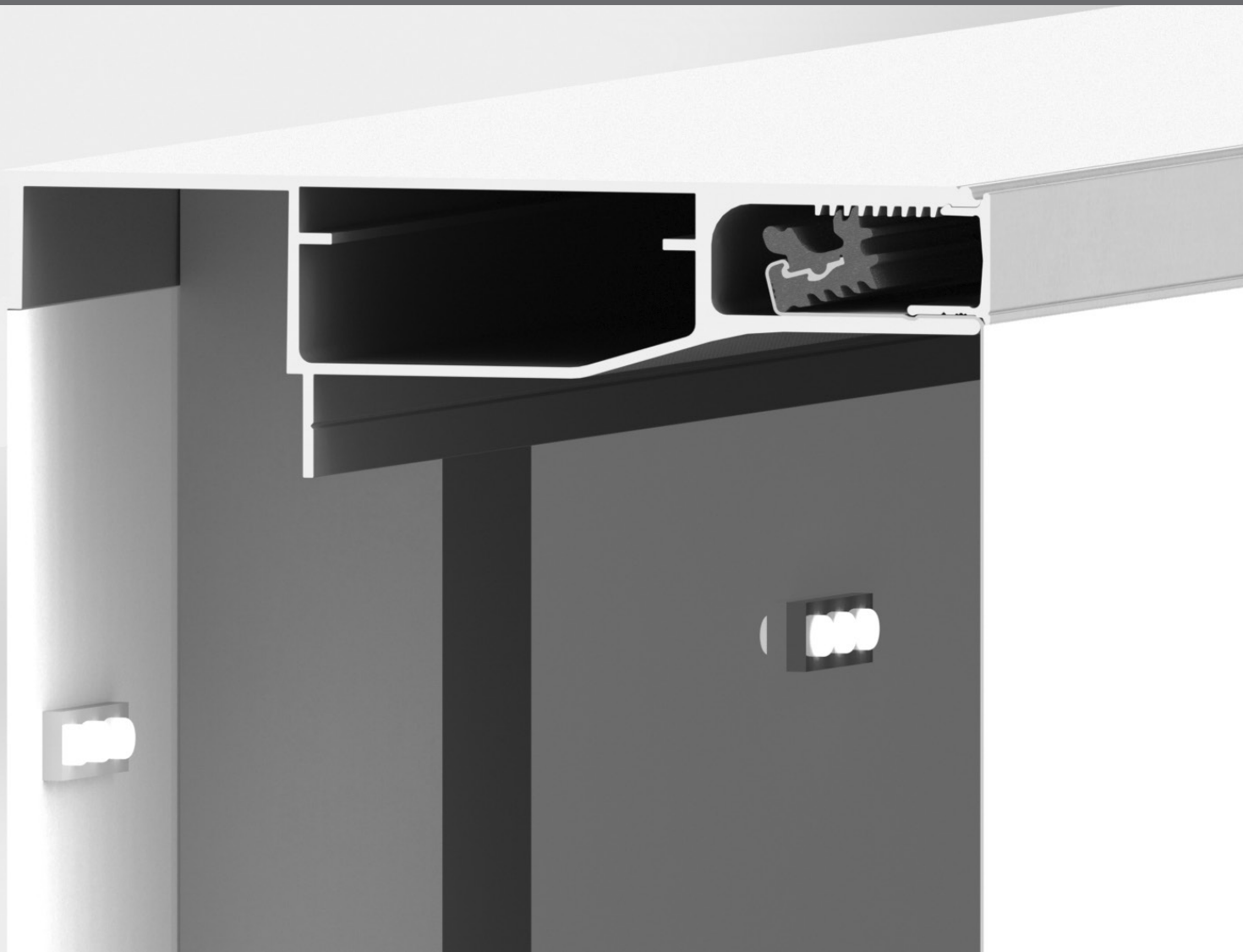

Technical additional
information

Static

For large format flex systems and exposed placements on high buildings or in the vicinity of the coast, you will require precise information regarding the performance capabilities of our tensioned profile systems.

We have subjected our profiles to comprehensive testing by independent test institutes and will be happy to assist you with our knowledge, expertise and static values regarding tension testing.

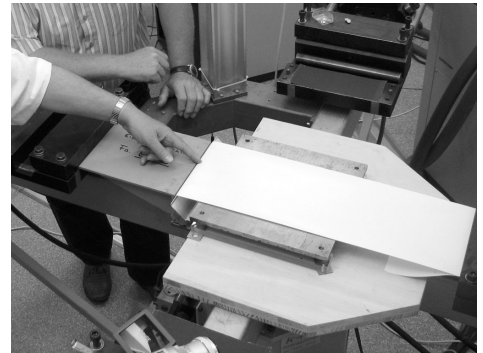

Special profiles

If you can not find the right profile in our product range, we also offer the possibility of project-related special profiles.

We are happy to advise you on these topics.

Please note the following dimensions for kits and frames:

EPS 1-111 GRIP Front opening Retrofit JR $t = 2,5 \text{ mm}$

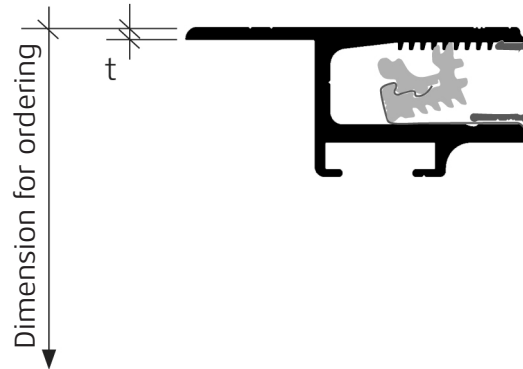

Bending

As part of our „Profil.Plus“ service, we can shape your profiles to your individual needs using CNC control. Further details on request.

Please note for the profiles EPS 1-102 and EPS 1-121:
The profile cannot be bent using CNC or be shaped by sawing it, because the GRIP Front opening cover cannot be shaped.

Please note for the profile EPS 1-111:
The profile cannot be bent using CNC, but without the GRIP Front opening cover shaping can be achieved by sawing into it:

- Bending radius of sawing > 230 mm

EPS

SYSTEMS

EPS Systems KG
Obere Leimbach 6
57074 Siegen/Germany
Fon +49 (0) 271.338829-00
info@eps-systems.de
www.eps-systems.de